

ECOPIC



SUMMARY

- THE COMPANY
- SELCLEANING®
- ECOPIC®
- DEPIGEONAL®
- ASTUCLIP KIT
- BIRD-OUT®
- CABLE BIRD®
- SELFIXING®
- CABLE BIRD® WIRE
- BIRD WIRE
- FILET NET
- ECOPIC® TILE
- PREDATOR®
- FIXNET® BOX



WWW.ECOPIC.COM

ABOUT US

PROTECT YOUR HERITAGE !



ECOPIC - the experts in the design, manufacture and distribution of bird deterrent systems, since 1986.



**QUALITY
TRACEABILITY
ISO STANDARD
9001 : 2015
WARRANTY**

ECOPIC has been specialised in the design, manufacture and distribution of bird deterrent systems, since 1986. The systems we use, do not cause any harm to the birds. **ECOPIC** products are designed purely to deter birds from landing on the protected surfaces.

Trademarks marketed by **ECOPIC** include:

ECOPIC® • DEPIGEONAL® • BIRD-OUT® • CABLE BIRD® • FIXNET® • SELCLEANING® • FILETNET • ECOPIC® TILE •

ECOPIC is responsible for the basic design and development of all products and systems. If necessary, the systems are registered and patented. We work in close collaboration with our many partners (e.g. raw materials suppliers) and purchase all raw materials direct. This ensures total quality control and traceability which in turn ensures the highest standards of quality. All manufacturing is performed directly by **ECOPIC** to further guarantee the quality.

Our products are often made of stainless-steel and polycarbonate (for the « base »). The steel wire we use gives an important mechanical resistance, and is produced to a minimum performance standard of 1700-2000N/mm2. This is important since guarantees the product efficiency through what we call "spring quality wire". Standards for resistances to salty mists are also established. We use the DIN50021, NSS ASTM B117 standard, recognized and used in the automobile industry. One of our material, **STEELINOX®+** passes the limit of 1000 hours of salty mists; again a unique standard of quality.

Our polycarbonate comes from worldwide, well-known manufacturers. No exotic products, are used due to our requirement for impeccable quality. The polycarbonate we use is 80% minimum virgin polycarbonate since UV resistance is essential ; only perfect control, guarantees an optimal resistance.

The above, summarises why our products are not simply « spikes ». Everyone does not manufactures quality products. Do not hesitate to ask for more details about the materials we use or our guarantees.

We manufacture in France where we have competent technicians, quick reaction times, a premium quality production facility and total quality control. All the above mentioned reasons enable us to offer you an unbeatable range of products.

We have many additional services to assist you :

- *Advice for quotations*
- *Assistance marketing*
- *Technical assistance*
- *Assistance for coding our products (EAN)*
- *A 24 hours delivery*
- *On-line systems.*

We offer you much more than just a range of products.



Christophe BOYER





ECOPIC is permanently represented in more than 38 countries.

ECOPIC is regularly confronted with every manner of bird problems and all kinds of architectural situations. Bird management can be complex. You need to rely upon an expert.

WHY SHOULD YOU PROTECT YOUR PROPERTY AGAINST BIRDS :

1st • Aesthetics

A single pigeon, gull or starling on your buildings causes little trouble. The aesthetic problem arises when the number of birds increases. In fact as few as twenty birds on a statue, a balcony or a cornice can seriously damage the architecture.

2nd • Excretions

Bird faeces causes quite an eyesore, but more importantly it causes structural problems. Bird faeces are extremely acidic, and will chemically burn the building surfaces.

3rd • Health

The proliferation of birds generates the risk of illness through the spread of more than 60 diseases :

- **Virals infections** : flu, paramixovirus...
- **Parasitics infections** : teniasis, ectoparasitic infestations
- **Fungal infections**.

WE HAVE IDENTIFIED SEVERAL DIFFERENT ZONES :

- **Low pressure** :
Used for resting only.
- **Medium pressure** :
Used for observing feeding areas (e.g. a cornice over a restaurant), sunbathing...
- **High pressure zone** :
Nesting...

One or several **ECOPIC** products correspond to each of these zones.

Be careful, on some buildings there are zones on which few birds will land. These are usually places that are exposed to wind currents. In this case, you will rarely find pigeons, but gulls or seagulls may persist.

Careful observation is essential ; do not hesitate to contact the **ECOPIC** team. We have been the experts in bird control for more than 30 years.





Active professional cleaner. Prepares supports for bird deterrent systems like **ECOPIC®**, **DEPIGEONAL®**, **BIRD-OUT®**, **CABLEBIRD®**...



ACTION

Used to prepare supports before installation of **ECOPIC®**, **DEPIGEONAL®**, **BIRD-OUT®**, **CABLEBIRD®**, **BIRDWIRE®**...

Recommended for all surfaces : stone, concrete, building façade, zinc, building cladding...

MAIN ADVANTAGES

- Product based on natural essential oils
- Fragrance of natural essences of plants

DESCRIPTION

- 1 litre can
- Professional cleaner with natural plant extracts
- Dilute in water
- The surface cleaned with 1 litre depends on the type of surface cleaned and its condition



SELCLEANING® CONCENTRATE PRODUCT	QUANTITY OF WATER TO ADD	QUANTITY OF READY TO USE PRODUCT
0,5 Litre	2 Litres	2,5 Litres
1 Litre	4 Litres	5 Litres
2 Litres	8 Litres	10 Litres

*Guarantee - ECOPIC conditions available upon simply request. Pictures and drawings non-contractual - 24/06 - © 2024 copyright all rights reserved





Active professional cleaner. Prepares supports for bird deterrent systems like **ECOPIC®**, **DEPIGEONAL®**, **BIRD-OUT®**, **CABLEBIRD®**...



SELCLEANING®

REF.	DESCRIPTION	PACKAGING
SEL003	SELCLEANING®	1 liter can

- Cleans all surfaces : stone, concrete, renovating, zinc, boarding...
- Prepare supports for **ECOPIC®** bird deterrent systems.
- Safe for users and the environment.



COMPOSITION

Less than 5 % : Anionic surface agents, amphoteric surface agents, not ionic surface agents, perfume, Methylchloroisothiazolinone, Methylisothiazolinone, linalool.

DIRECTIONS FOR USE

- Dilute 1 litre of professional cleaner into 4 liters of water.
- Spray on the surface to clean.
- Leave to soak in for a few minutes and then brush.
- Wipe the damp surface with a dry rag.
- Dose depending of the use



USES

Cleaning greasy surfaces like :

- gutters
- balconies
- roofs
- cornices
- rails
- banisters
- terraces
- car bodies
- motorcycles

PRECAUTION

- No special precautions required.

STORAGE

- Do not expose to frost or direct sunlight.
- In order to preserve **SELCLEANING®**, do not expose to temperature higher than 50°C.
- Technical specifications available on request.

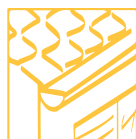

Gutters



Wood



Tiles



Balconies



Cornices





Deterrent spikes to repel birds. Recommended for low medium and strong bird pressures.



ACTION

Once fitted, **ECOPIC®** forms a virtually invisible barrier to deter birds from landing or nesting on the fitted surfaces, whilst causing them no harm.

MAIN ADVANTAGES

- Easy to fit
- Discreet
- Economical
- Reliable

PROTECTION

- All types of building
- All types of surface
- All types of gutter

DESCRIPTION

Spikes in stainless-steel 302 / **STEELINOX®** / **STEELINOX®+** (Ø 1,3 mm or 1,4 mm), jointly pliable on a polycarbonate base, mass UV-stabilised.

ECOPIC® is manufactured using noncorroding materials.

ECOPIC® has a 10 years warranty*.

FITTING

ECOPIC® can be fitted to all surfaces (zinc, wood, stone, reinforced, concrete, cement mortar, marble...).

Installation : optimum weather conditions

- Temperatures between +5°C and +30°C, sheltered from rain.

Preparation of the surface :

- Cleaning with **SELCLEANING®**
- Removal of dust, dirt and grease, drying
- If necessary, application of a primer on porous surfaces.

Simple, fast, precise fitting :

- With silicone adhesive
- With screws or nails.

Recommendation for optimised gluing :

SELFIXING® silicone adhesive.

ECOCLIPS 3 can be fitted to all types of gutter with a rim of 12 to 30 mm (metallic or synthetic materials).

- Fitting by simply clipping to the outer part of the gutter.



*Guarantee - ECOPIC conditions available upon simply request. Pictures and drawings non-contractual - 23/06 - © 2023 copyright all rights reserved





Deterrent spikes to repel birds. Recommended for low medium and strong bird pressures.



ECOPIC® E2

REF.	DESCRIPTION	PACKAGING
ECO143	E2 PCB 100 mm	50 linear meter

- Product dimensions : L 33 x W. 6 x H 10 cm.
- 13 spikes in 2 rows.
- Packaging dimensions : 41 x 35 x 30 cm box for 6,5 kg.
- Width protected : from 6 cm to 10 cm.
- Protection: pigeons, carrion crows and magpies.
- Stainless-steel wire 302 / **STEELINOX®** / **STEELINOX®+** Ø 1,3 mm

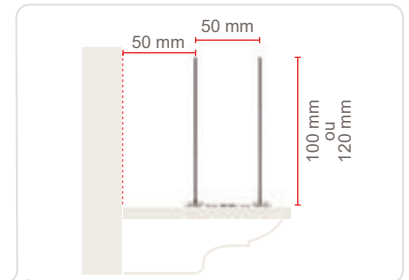

REF.	DESCRIPTION	PACKAGING
ECO147	E2 PCB 120 mm	50 linear meter

- Product dimensions : L 33 x W 6 X H 12 cm.
- 13 spikes in 2 rows.
- Packaging dimensions : 41 x 35 x 30 cm box for 7 kg.
- Width protected : from 6 cm to 10 cm.
- Protection: pigeons, carrion crows and magpies.
- Stainless-steel wire 302 / **STEELINOX®** / **STEELINOX®+** Ø 1,3 mm

ECOPIC® E4

REF.	DESCRIPTION	PACKAGING
ECO146	E4 PCB 85/115 mm	50 linear meter

- Product dimensions : L 33 x W 14 x H 8,5/11,5 cm.
- 26 spikes in 4 rows.
- Packaging dimensions : 70,5 x 51,5 x 32 cm box for 9,5 kg.
- Width protected : from 14 cm to 19 cm.
- Protection: pigeons, carrion crows, magpies, gulls, raven and wood pigeons.
- Stainless-steel wire 302 / **STEELINOX®** / **STEELINOX®+** Ø 1,3 mm.

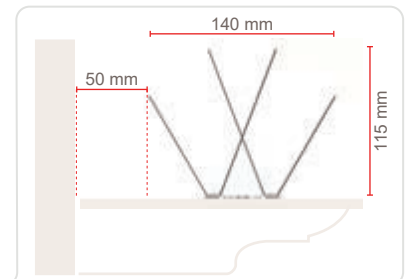

ECOPIC® E6₂₀₀

REF.	DESCRIPTION	PACKAGING
ECO105	E6 PCB 85/100/120mm	20 linear meter

- Product dimensions : L 33,7 x W 20 x H 8,5/10/12 cm.
- 36 spikes in 6 rows..
- Packaging dimensions : 45 x 36 x 45 cm x box for 5,8 kg.
- Width protected : from 20 cm to 25 cm.
- Protection: pigeons, carrion crows, magpies, gulls, raven, wood pigeons & seagulls.
- Stainless-steel wire 302 - Ø 1,4 mm.

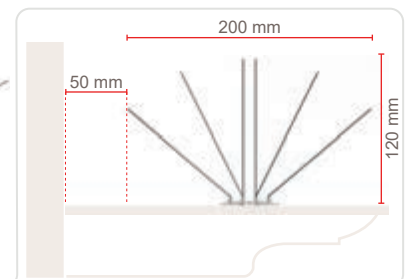
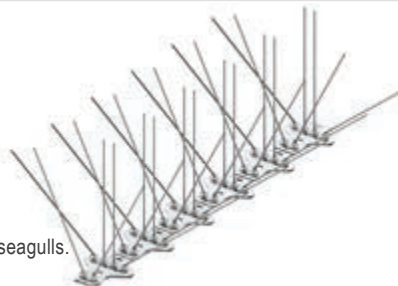

ECOCLIPS 3

REF.	DESCRIPTION	PACKAGING
ECO145	Ecoclips 3	20 linear meter

- 240 clips either 12 clips / meter.
- Gutter rims with a diameter of 12 to 30 cm.
- Product dimensions : L 4,5 x H 13,5 cm.
- Packaging dimensions : 35,5 x 22,5 x 15 cm box for 1,9 kg.
- Width protected : gutter edges.
- Protection : pigeons, carrion crows and magpies.
- Spikes in **STEELINOX®** / **STEELINOX®+** Ø 1,3 mm.

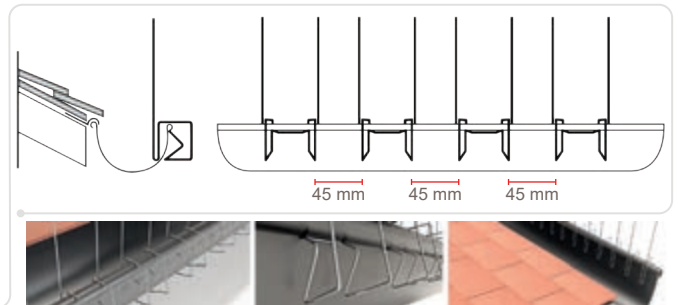
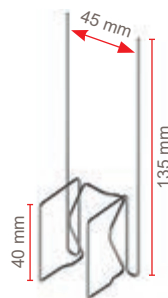

ECOPIC® EV6/EV12 SPECIAL FOR SHUTTERS

REF.	DESCRIPTION	PACKAGING
ECO118	EV6 110 mm	20 linear meter

- Product dimensions : L 36 x W 1 x H 11 cm.
- 6 spikes 11cm.
- Packaging dimensions : 40 x 20 x 11 cm box for 1,39 kg.
- Width protected : up to 3 cm.
- Protection: pigeons, carrion crows and magpies.
- Stainless-steel wire 302 - Ø 1,2 mm.

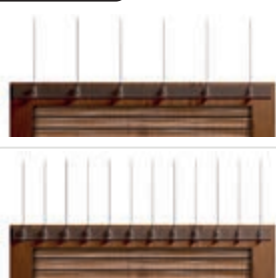

REF.	DESCRIPTION	PACKAGING
ECO119	EV12 110 mm	20 linear meter

- Product dimensions : L 36 x W 1 x H 11 cm.
- 12 spikes 11cm.
- Packaging dimensions : 40 x 20 x 11 cm box for 1,91 kg.
- Width protected : up to 3 cm.
- Protection: pigeons, carrion crows, magpies, sparrows and starlings
- Stainless-steel wire 302 - Ø 1,2 mm.





Deterrent spikes to repel birds. Recommended for low medium and strong bird pressures.



ACTION

DEPIGEONAL® forms a virtually invisible protective barrier, ensuring conservation of buildings and good hygiene, as well as a free gutter flow, without harming birds.

MAIN ADVANTAGES

- Easy to fit
- Discreet
- Economical
- Reliable

PROTECTION

- All types of building
- All types of surface
- All types of gutter

DESCRIPTION

Spikes in stainless-steel 302/ **STEELINOX®** / **STEELINOX®+** (Ø 1,3 mm or 1,4 mm).

Manufactured using non-corroding materials. Polycarbonate base mass UV-stabilised.

DEPIGEONAL® has a 10 years warranty*.

FITTING

DEPIGEONAL® can be fitted to all surfaces (zinc, wood, stone, reinforced, concrete, cement mortar, marble...).

Installation : optimum weather conditions

- Temperatures between +5°C and +30°C, sheltered from rain.

Preparation of the surface :

- Cleaning with **SELCLEANING®**
- Removal of dust, dirt and grease, drying
- If necessary, application of a primer on porous surfaces.

Simple, fast, precise fitting :

- With silicone adhesive
- With screws or nails.

Recommendation for optimised gluing :

SELFIXING® silicone adhesive.

ULTRA CLIPS 3 can be fitted to all types of gutter with a rim of 12 to 30 mm (metallic or synthetic materials).

- Fitting by simply clipping to the outer part of the gutter.



*Guarantee - ECOPIC conditions available upon simply request. Pictures and drawings non-contractual - 23/06 - © 2023 copyright all rights reserved





Deterrent spikes to repel birds. Recommended for low medium and strong bird pressures.



DEPIGEONAL® ULTRA 1

REF.	DESCRIPTION	PACKAGING
DEP115	ULTRA 1	40 linear meter

- Product dimensions : L 31 x W 5,5 x H 11 cm.
- 18 spikes in 3 row.
- Packaging dimensions : 35 x 35 x 35 cm box for 5,14 kg.
- Protected width : from 5 cm to 10,5 cm.
- Protection: pigeons, carrion crows, magpies, sparrows and starlings
- Stainless-steel wire 302 / **STEELINOX®** / **STEELINOX®+** Ø 1,3 mm.

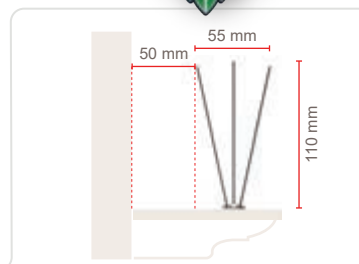

DEPIGEONAL® ULTRA 2

REF.	DESCRIPTION	PACKAGING
DEP112	ULTRA 2	40 linear meter

- Product dimensions : L 31 x W 10 x H 11 cm.
- 18 spikes in 3 rows.
- Packaging dimensions : 35 x 35 x 35 cm box for 5,14 kg.
- Protected width : from 10 cm to 15 cm.
- Protection: pigeons, carrion crows, magpies, sparrows and starlings
- Stainless-steel wire 302 / **STEELINOX®** / **STEELINOX®+** Ø 1,3 mm.

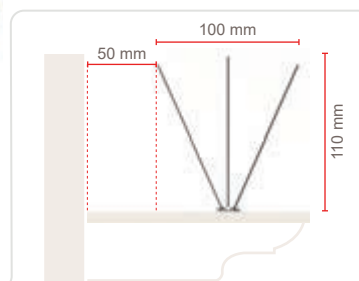
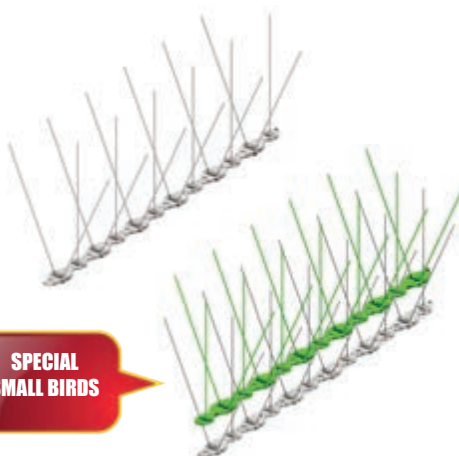

DEPIGEONAL® ULTRA 4

REF.	DESCRIPTION	PACKAGING
DEP116	ULTRA 4	40 linear meter

- Product dimensions : L 33,7 x W 15,5 x H 12 cm.
- 24 spikes in 4 rows.
- Packaging dimensions : 60 x 40 x 40 cm box for 8,8 kg.
- Protected width : from 15,5 cm to 20,5 cm.
- Protection: pigeons, carrion crows, magpies, gulls, crows, wood pigeons & seagulls
- Stainless-steel wire 302 - Ø 1,4 mm.

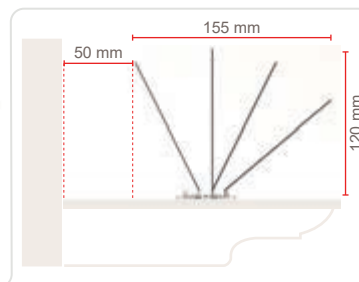

ULTRALIPS 3

REF.	DESCRIPTION	PACKAGING
DEP125	Ultraclips 3	20 linear meter

- 240 clips either 12 clips / meter.
- Gutter rims with a diameter of 12 to 30 cm.
- Product dimensions : L 4,5 x H 13,5 cm.
- Packaging dimensions : 35,5 x 22,5 x 15 cm box for 1,9 kg.
- Width protected : gutter edges.
- Protection : pigeons, carrion crows and magpies.
- Spikes in **STEELINOX®** / **STEELINOX®+** Ø 1,3 mm.

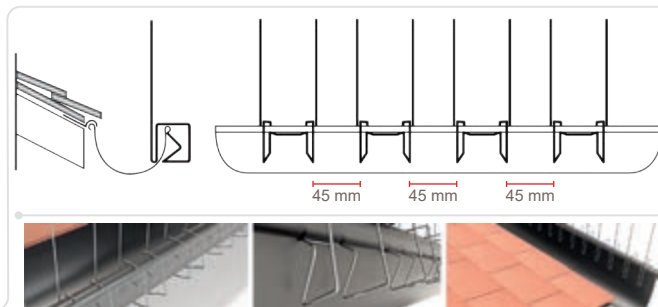
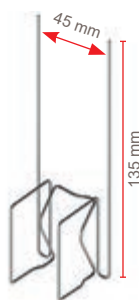

DEPIGEONAL® EV6/EV12 **SPECIAL FOR SHUTTERS**

REF.	DESCRIPTION	PACKAGING
DEP118	EV6 110 mm	20 linear meter

- Product dimensions : L 36 x W 1 x H 11 cm.
- 6 spikes 11cm.
- Packaging dimensions : 40 x 20 x 11 cm box for 1,39 kg.
- Width protected : up to 3 cm.
- Protection: pigeons, carrion crows and magpies.
- Stainless-steel wire 302 - Ø 1,2 mm.

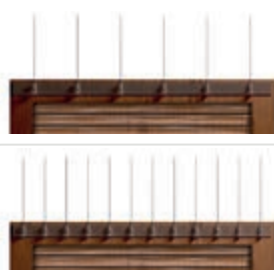

REF.	DESCRIPTION	PACKAGING
DEP119	EV12 110 mm	20 linear meter

- Product dimensions : L 36 x W 1 x H 11 cm.
- 12 spikes 11cm.
- Packaging dimensions : 40 x 20 x 11 cm box for 1,91 kg.
- Width protected : up to 3 cm.
- Protection: pigeons, carrion crows, magpies, sparrows and starlings
- Stainless-steel wire 302 - Ø 1,2 mm.



ASTUCLIP KIT

PROTECT YOUR HERITAGE !



The dissuasive process for birds removal



ACTION

ASTUCLIP Kit is an accessory that keeps the Ultra 1 by simply clipping on the outside profile of the gutter while respecting the flow of rainwater.

Kit of 10 LM gutter protection, 32 unit of Ultra 1 with 64 clips **ASTUCLIP**.

Only available in kit of 10 LM Ultra 1 + 64 clips.

MAIN ADVANTAGES

- Economical
- Easy to fit
- Ready to use

PROTECTION

- Half round gutters

DESCRIPTION

Suitable for bead gutter with maximum diameter :

ASTUCLIP (Ref: ECO144B): Maximum 22 mm.

ASTUCLIP has a 10 years warranty*.

FITTING

Astuclip can be fitted to half round gutters (zinc/aluminium or synthetic materials) by simply clipping on the outside profile of the gutter.

Insatallation : Optimun weather conditions

- Temperatures between +5°C and +30°C, sheltered from rain.

Preparation of the surface :

- Cleaning with **SELCLEANING®**
- Removal of dust, dirt and grease, drying

Simple, fast, precise fitting :

- Apply pressure with the thumd of the hand on the clip, it is immediatly operational.

Recommendation for optimized clipping (by gluing) :

SELFIXING® silicone adhesive.

It is recommended never to install products that could interfere with the functioning of the gutter.



ASTUCLIP KIT

PROTECT YOUR HERITAGE !



The dissuasive process for birds removal



ASTUCLIP KIT

REF.	DESCRIPTION	PACKAGING
ECO144B	Astuclip kit	Kit of 10 LM of Ultra 1 + 64 clips

Astuclip kit (10 LM of gutter protection)

- Packaging dimensions : 34,5 x 22 x 14,5 cm / 1.5 kg
- Special for gutters with a maximum diameter hem 22 mm

The kit includes :

ASTUCLIP

- 64 clips **Astuclips** (Stainless-steel 301 grade)
- Size of the clip : width 10 mm x height 49,75 mm

ULTRA 1

- 32 units of **Ultra 1**
- Mass U.V. stabilised and 100% virgin polycarbonate base
- 18 Stainless-steel 302 grade spikes **STEELINOX® / STEELINOX®+** Ø 1,3 mm
- Size of the unit : lenght 310 x width 55 x height 110 mm
- Width protected : Gutter edges
- Protection: pigeons, carrion crows and magpies

Only available in kit of 10 LM Ultra 1 + 64 clips.

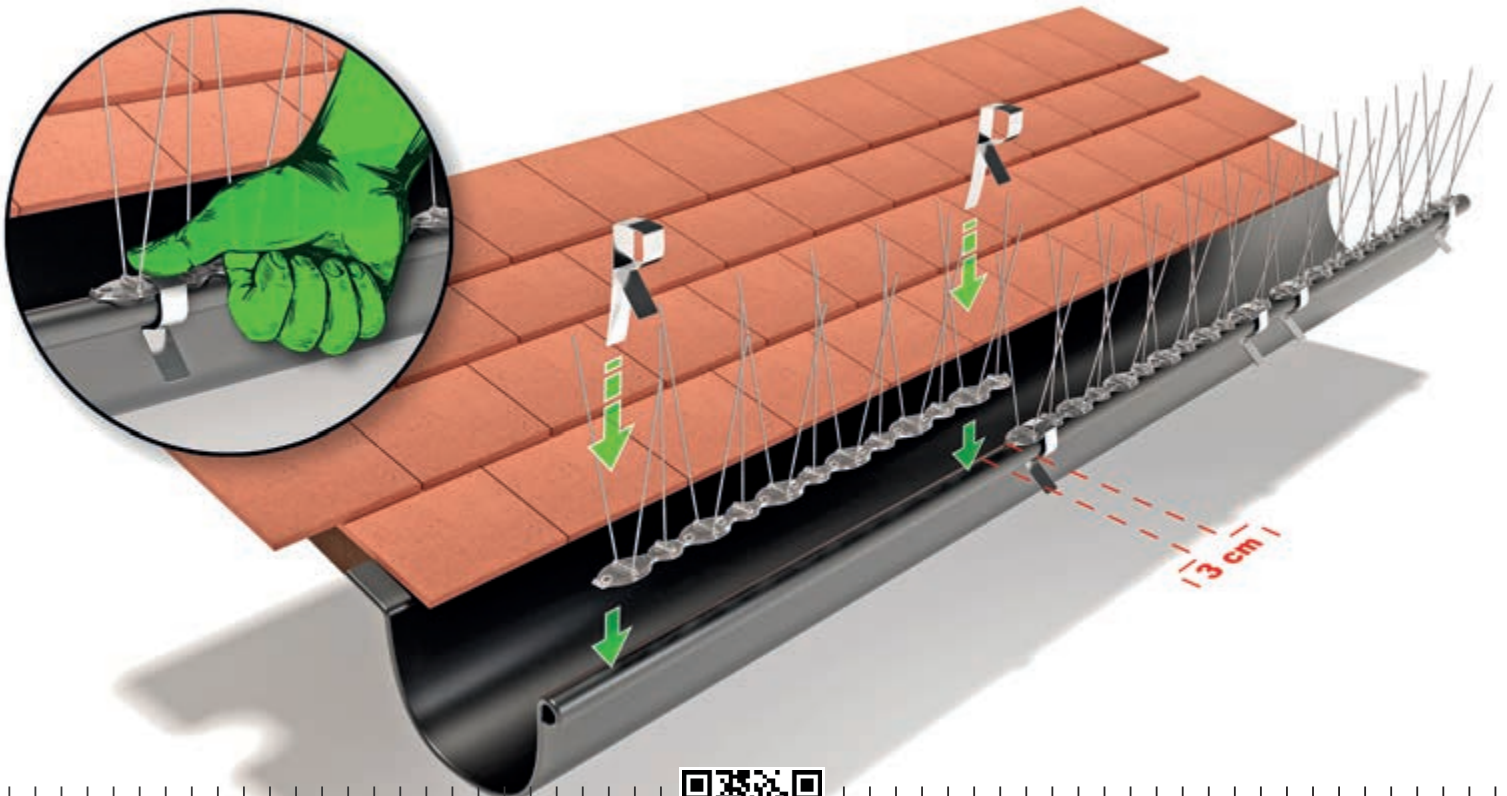
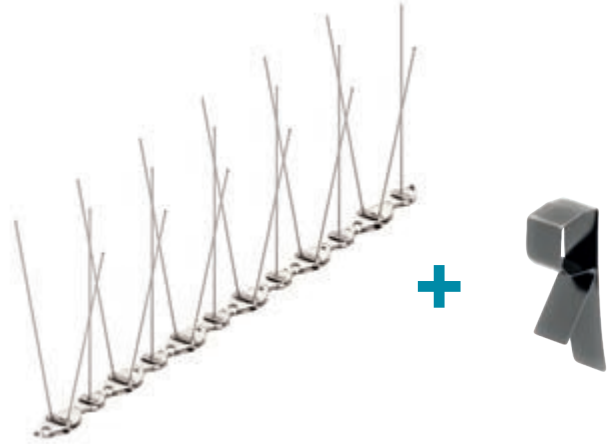



Electro-vibratory deterrent system to repel birds. Recommended for all pressure zones.



ACTION

BIRD-OUT® provides an efficient barrier to protect against birds. Its components are flexible, so they fit all architectural profiles perfectly, whilst preserving the aesthetic quality of the area to be protected.

MAIN ADVANTAGES

- Very fast fitting
- Can be adapted to all surfaces
- Discreet
- Available in Steelinox® or stainless-steel

PROTECTION

- Sloping roofs, flat roofs
- Bridges
- Statues
- Cornices, tympana
- Bell towers
- Inner courtyards
- Street-lights

DESCRIPTION

BIRD-OUT® uses a sequential electric generator equipped with a condenser, to produce a repellent effect that is harmless to birds, according to human standards.

- System available in Steelinox® or in stainless-steel rods Ø 2 mm, length 1 m.
- Easy to bend to follow the profile of the architecture.
- Directional changes can easily be produced using BDO clips or torsion springs.

BIRD-OUT® has a 10 years warranty* (excludes the generator).

FITTING

BIRD-OUT® can be fitted to all types of surface (zinc, wood, stone...).

- Installation :**
- Optimum weather conditions thermal range +5° to +30° C.

Simple, fast, precise fitting:

- With silicone adhesive
- With screws or nails.

Recommendation for optimised gluing :
SELFIXING® silicone adhesive.

We do not recommend fitting the supports on surfaces with easy public access (window ledges, etc.).

Installation of a warning sign is required.

MAINTENANCE MANDATORY Contact us for details



*Guarantee - ECOPIC conditions available upon simply request. Pictures and drawings non-contractual - 23/06 - © 2023 copyright all rights reserved





Electro-vibratory deterrent system to repel birds. Recommended for all pressure zones.



BIRD-OUT® STEELINOX®/INOX

REF.	DESCRIPTION	PACKAGING
BDO101	Bird-out® Steelinox®	20 M kit
BDO107	Bird-out® Inox	20 M kit
BDO108	Bird-out® Evolution	20 M kit
BDO116	Bird-out® Evolution Inox	20 M kit

One kit includes :

- 40 bars (Ø 2mm – length of 1m).
- 40 polycarbonate supports anti-UV treated in the mass
- 2 0,50m coils of springs or BDO Clip (getting 40 connections of 2,5 cm).
- 2 triple connexions + 2 heat shrink tubing.
- Packaging dimensions : 10 x10 x 100 cm.
- Packaging weight : 1,4 kg.
- Widths protected : see technical specifications available on request.
- Technical sheet for fitting supplied in each pack.

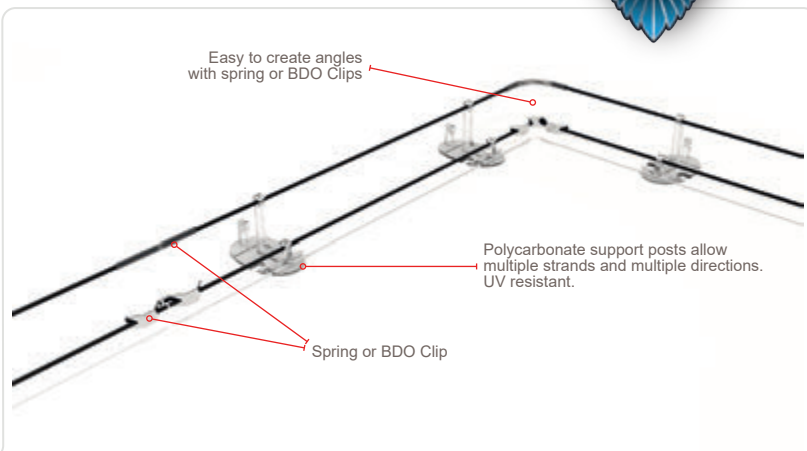

MOUNT

REF.	DESCRIPTION	PACKAGING
BDO012	Mount	Unit

- Multi-surface mounting and multi-directional positioning, manufactured in UV-stabilised polycarbonate.
- Anti-arcing safety system. Water repellent system. Historical monuments require 3 mounts per metre.

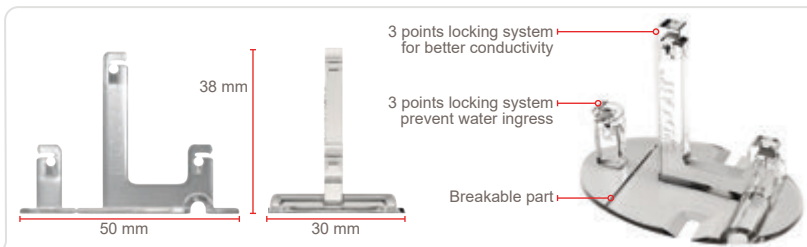

BAR

REF.	DESCRIPTION	PACKAGING
BDO011	Steelinox® bar	Unit
BDO014	Stainless-Steel bar	Unit

- Bar made of Steelinox® or stainless-steel Ø 2 mm
- length 1 m.
- Can easily be cut to the required length or bent to follow the profile of the architecture.



SPRING

REF.	DESCRIPTION	PACKAGING
BDO017	Bird-out® Spring	Unit

- Length : 0,50 ml.

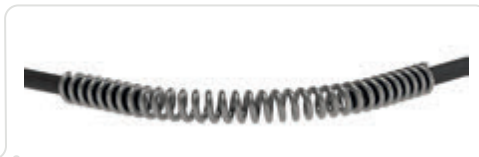

BDO CLIP

REF.	DESCRIPTION	PACKAGING
BDO009	BDO Clip	Unit

- Length : 40 mm.
- Width : 6 mm.
- The clip ensures perfect fixing of the rods akin to a « welding process », while still facilitating directional changes without strain or pressure.



TRIPLE CONNEXION

REF.	DESCRIPTION	PACKAGING
BDO018	Triple connexion	Unit
EVO045	Black heat shrink tubing	Unit

- To connect the EVO100 cable to the bars
- Standard EN50143.
- Heat shrink tubing (black or white)



ACCESSORIES

DOUBLE CABLE

Ref.: EVO100
Description : Bird-out® double cable
Packaging : Spool of 50 M

- To safely connect two spaced locations of the BIRD-OUT® circuit.
- Double cable with RZ flame retardant PVC sheath and multi-wire copper conductive material.
- Light gray color, it has a black sheath and another red to locate the side ⊕, ideal when going through a chute.
- Standard IEC 60228 and IEC 20-22 II



GENERATOR

Ref.: EVO050
Description : Central generator 02
Packaging : Unit

- 220 volts generator.
- Technical specifications on request.





Deterrent spikes to repel birds. Recommended for low medium and strong bird pressures.



ACTION

The dual action of **CABLE BIRD®** rods prevents pigeons from settling on buildings ledges.

When the bird attempts to land, the rod rotates (**ECOPIC** patent) and vibrates with a spring effect.

The vibrations of the rod prevent the bird from settling.

MAIN ADVANTAGES

- Very fast fitting, with silicone adhesive
- Dual-action for guaranteed results
- Discreet
- Support fitted with no grilling
- No risk for hurting the birds
- Ideal for windowsills
- Good value, economical

No deterioration of the support because of non-drilling

PROTECTION

- All types of edifices
- Cornices
- Guardrails
- Gutters
- Handrails
- Windowsills



DESCRIPTION

STEELINOX® rod system (**ECOPIC** Product and Brand) fitted on UV-stabilised polycarbonate supports that are stuck to the surface to be protected.

To increase protection, supports can be single or double, holding one or two rods.

CABLE BIRD® has a 5 years warranty*.

FITTING

CABLE BIRD® can be fitted to all types of supports (zinc, wood, stone...).

Very fast using silicone adhesive.

Recommendation for optimised gluing : **SELFIXING®** silicone adhesive.

*Guarantee : ECOPIC conditions available upon simply request. Pictures and drawings non-contractual - 23/06 - © 2023 copyright all rights reserved





Deterrent spikes to repel birds. Recommended for low medium and strong bird pressures.



CABLE BIRD® 1

REF.	DESCRIPTION	PACKAGING
CBD104	Cable Bird® Simple	50 linear meter

- Product dimensions : 50 x 3,7 x 9 cm.
- Packaging dimensions : 58 x 15 x 7 cm box for 1,835 kg.
- Protected width : 3,7 to 6,7 cm.

One kit includes :

- 200 polycarbonate supports anti-UV treated in the mass
- 200 simple **STEELINOX®** hooks Ø 1.2 mm.
The material used permits a high resistance, so high efficiency.
Spring effect combined cable / hook.
- 100 **STEELINOX®** Ø 1.4 mm rods.

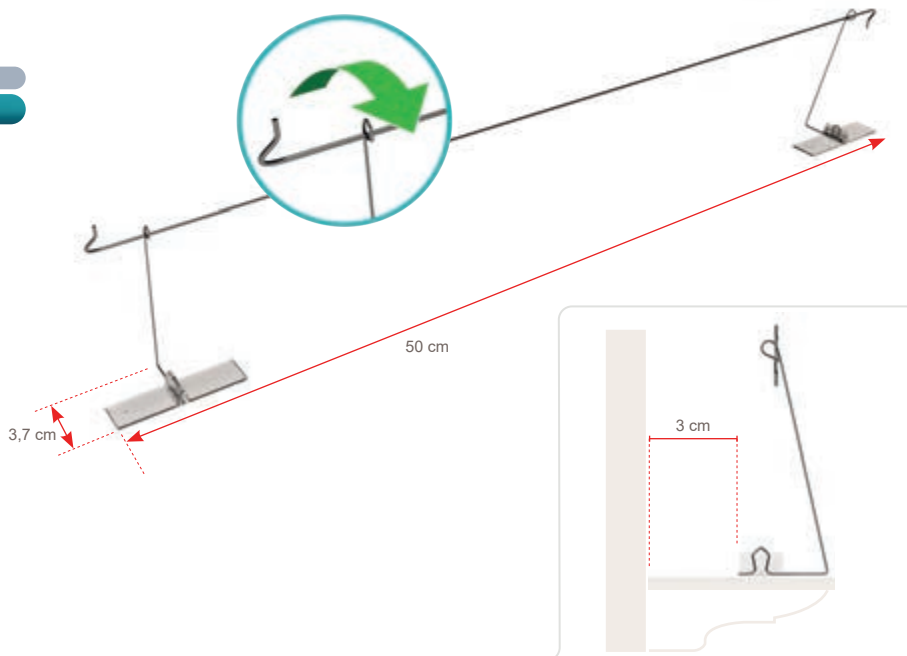

CABLE BIRD® 2

REF.	DESCRIPTION	PACKAGING
CBD105	Cable Bird® Double	50 linear meter

- Product dimensions : 50 x 5 x 9 cm.
- Packaging dimensions : 58 x 15 x 7 cm box for 2,752 kg.
- Protected width : 5 to 8 cm.

One kit includes :

- 200 polycarbonate supports anti-UV treated in the mass
- 200 double **STEELINOX®** hooks Ø 1.2 mm.
The material used permits a high resistance, so high efficiency.
Spring effect combined cable / hook.
- 200 **STEELINOX®** Ø 1.4 mm rods.

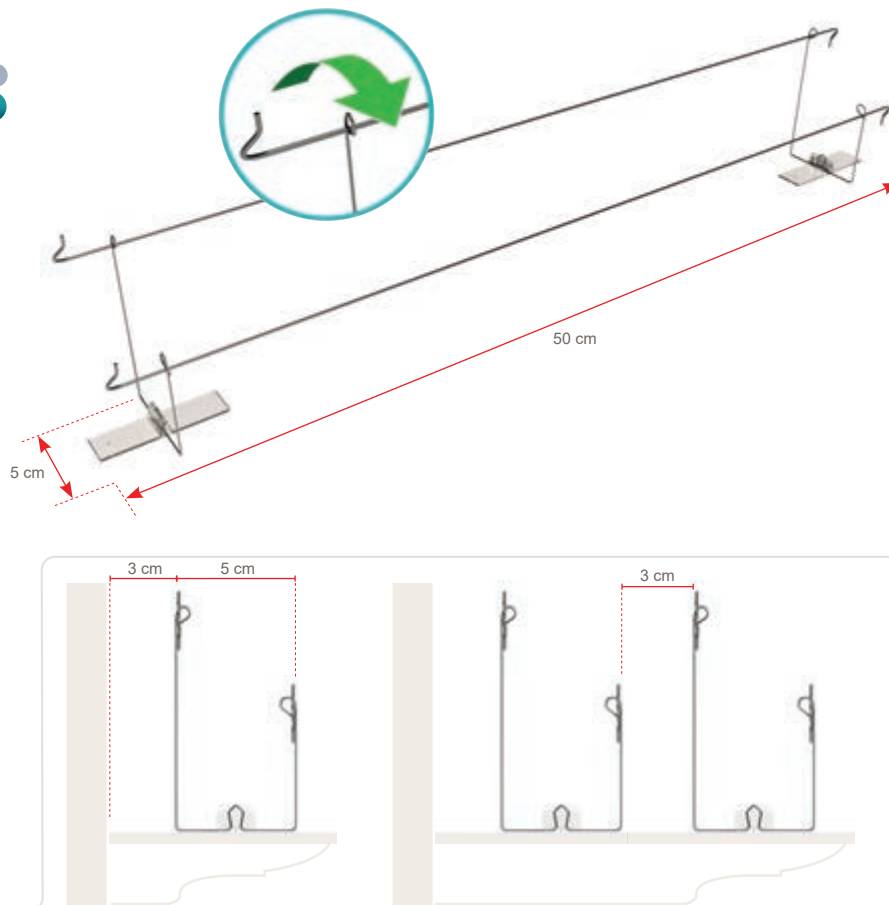



Special for ECOPIC anti-bird spikes



ACTION

Thanks to its great versatility, **SELFIXING®** silicone allows the surfaces such as aluminum, rigid PVC, glass, concrete (clean and dust-free), etc. Installation of **ECOPIC** products without using a primer on many.

MAIN ADVANTAGES

- Appearance: Pasty
- Color: Colourless translucent
- Odour: Very faint
- Application temperature: +5 to +40 °C
- Temperature resistance : -40 to +150 °C

PROTECTION

A silicone sealant for bonding **ECOPIC** products. **SELFIXING®** is a silicone sealant recommended for the installation of **ECOPIC** products.

DESCRIPTION

It is a neutral silicone that can be applied cold, without primer, to: stone, concrete, zinc, etc.

SELFIXING® silicone has exceptional resistance to bad weather, particularly UV and extreme temperatures.

It is particularly suitable for making sealing and expansion joints in the building industry.

FITTING

SELFIXING® silicone is applied using a manual or pneumatic gun to dry surfaces, free of dust, grease or other pollutants that could hinder the bonding.

Clear them if necessary with **SELCLEANING®**.

Apply a regular bead an even bead to the underside of **ECOPIC** products, then place them on the surface to be bonded by pressing lightly.

Optimum climatic conditions for installation:

- Temperatures between +5°C and +40°C, away from rain.

Support preparation:

- Cleaning with **SELCLEANING®**
- Dusting, degreasing, drying

*Guarantee - ECOPIC conditions available upon simply request. Pictures and drawings non-contractual - 24/08 - © 2024 copyright all rights reserved





Special for ECOPIC anti-bird spikes



selfixing®

SELFIXING®

REF.	DESCRIPTION	PACKAGING
SIL001	Selfixing®	280 ML cartridge

INDICATION FOS USE :

- 13 to 16 linear meter / hour.
- 1 cartridge ± 10 m of ECOPIC®.

Apply to clean and dry surfaces when temperatures are between +5 and +40°C



UV RESISTANT



EXTREME TEMPERATURES



HIGH ELASTICITY



HIGH ADHESION



COLOURLESS TRANSLUCENT



USE WITH SILICONE GUN



PREPARE THE SUPPORT



CLEAN & DRY SUPPORT



APPLY A REGULAR BEAD OF SILICONE



INSTALL & PUSH DOWN





Stretched-wire system to prevent pigeons from setting on the ledges of buildings. Recommended for low bird pressures.



ACTION

Once fitted, **CABLE BIRD® WIRE** with its stretch cable spring action, prevents pigeons from landing on the ledges of buildings by obstructing the area.

The vibrations of the cable prevent birds from settling.

MAIN ADVANTAGES

- Very fast fitting, with silicone adhesive
- Dual-action for guaranteed results
- Discreet
- Support fitted with no grilling
- No risk for hurting the birds
- Ideal for windowsills
- Good value, economical

No deterioration of the support because of non-drilling

PROTECTION

- All types of edifices
- Cornices
- Guardrails
- Gutters
- Handrails
- Windowsills

DESCRIPTION

System of stainless-steel cable covered with nylon and tightened by a hook (which act as a spring).

CABLE BIRD® WIRE permits the **STEELINOX®** hooks to flex of about 1 cm.

CABLE BIRD® WIRE has a 5 years warranty*.

FITTING

CABLE BIRD® WIRE can be fitted to all types of support (zinc, wood, stone...).

Recommendation for optimised gluing :
Polyurethane glue.



*Guarantee : ECOPIG conditions available upon simply request. Pictures and drawings non-contractual - 23/06 - © 2023 copyright all rights reserved





Stretched-wire system to prevent pigeons from setting on the ledges of buildings. Recommended for low bird pressures.



CABLE BIRD® WIRE I

REF.	DESCRIPTION	PACKAGING
CBW001	Cable Bird® Wire Simple	100 linear meter

- Product dimensions : 50 x 3,7 x 9 cm.
- Packaging dimensions : 23 x 19 x 12 cm box for 1,46 kg.
- Protected width : 3,7 to 6,7 cm.

One kit includes :

- 250 polycarbonate supports, mass UV-stabilised.
- 50 single **STEELINOX®** hooks Ø 1,2 mm.
The material used permits a high resistance, so high efficiency.
Spring effect combined cable / hook.
- 1x100 m spool of nylon coated stainless steel Ø 0,7 mm.
- 200 clamps.

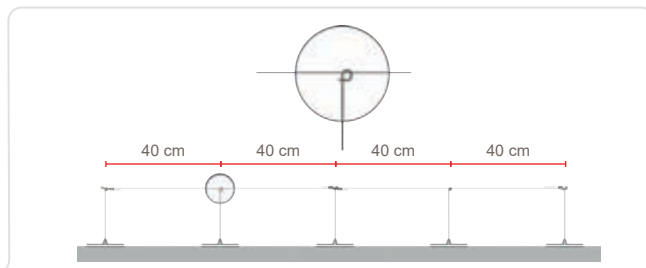
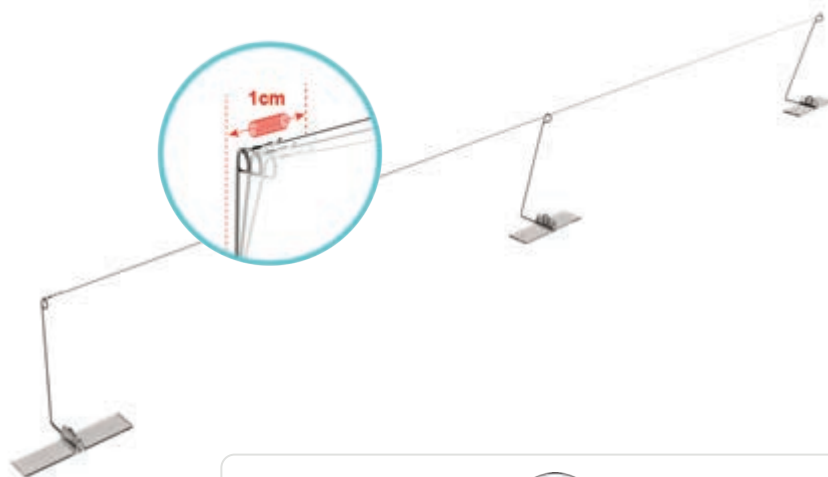

CABLE BIRD® WIRE 2

REF.	DESCRIPTION	PACKAGING
CBW002	Cable Bird® Wire Double	100 linear meter

- Product dimensions : 50 x 5 x 9 cm.
- Packaging dimensions : 23 x 19 x 12 cm box for 2,08 kg.
- Protected width : 5 to 8 cm.

One kit includes :

- 250 polycarbonate supports, mass UV-stabilised.
- 50 double **STEELINOX®** hooks Ø 1,2 mm.
The material used permits a high resistance, so high efficiency.
Spring effect combined cable / hook.
- 2x100 m spool of nylon coated stainless steel Ø 0,7 mm.
- 400 clamps.

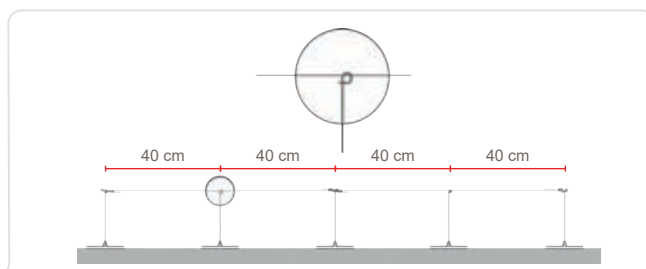
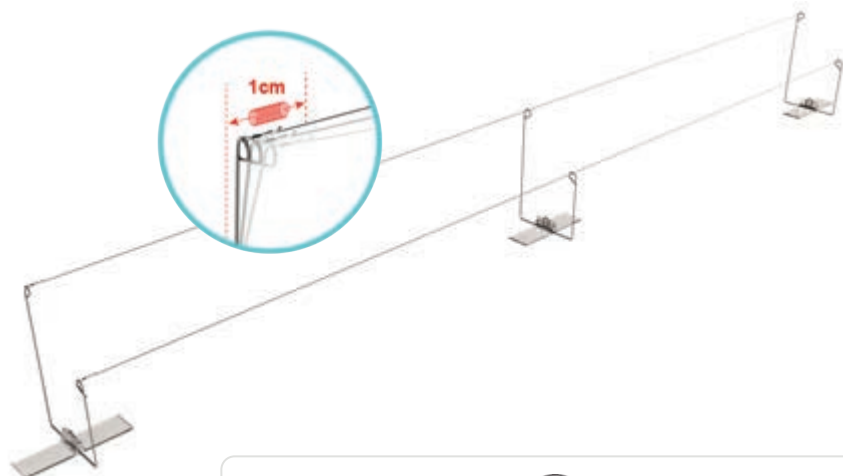



Stretched-wire system to prevent pigeons from setting on the ledges of buildings. Recommended for low bird pressures.

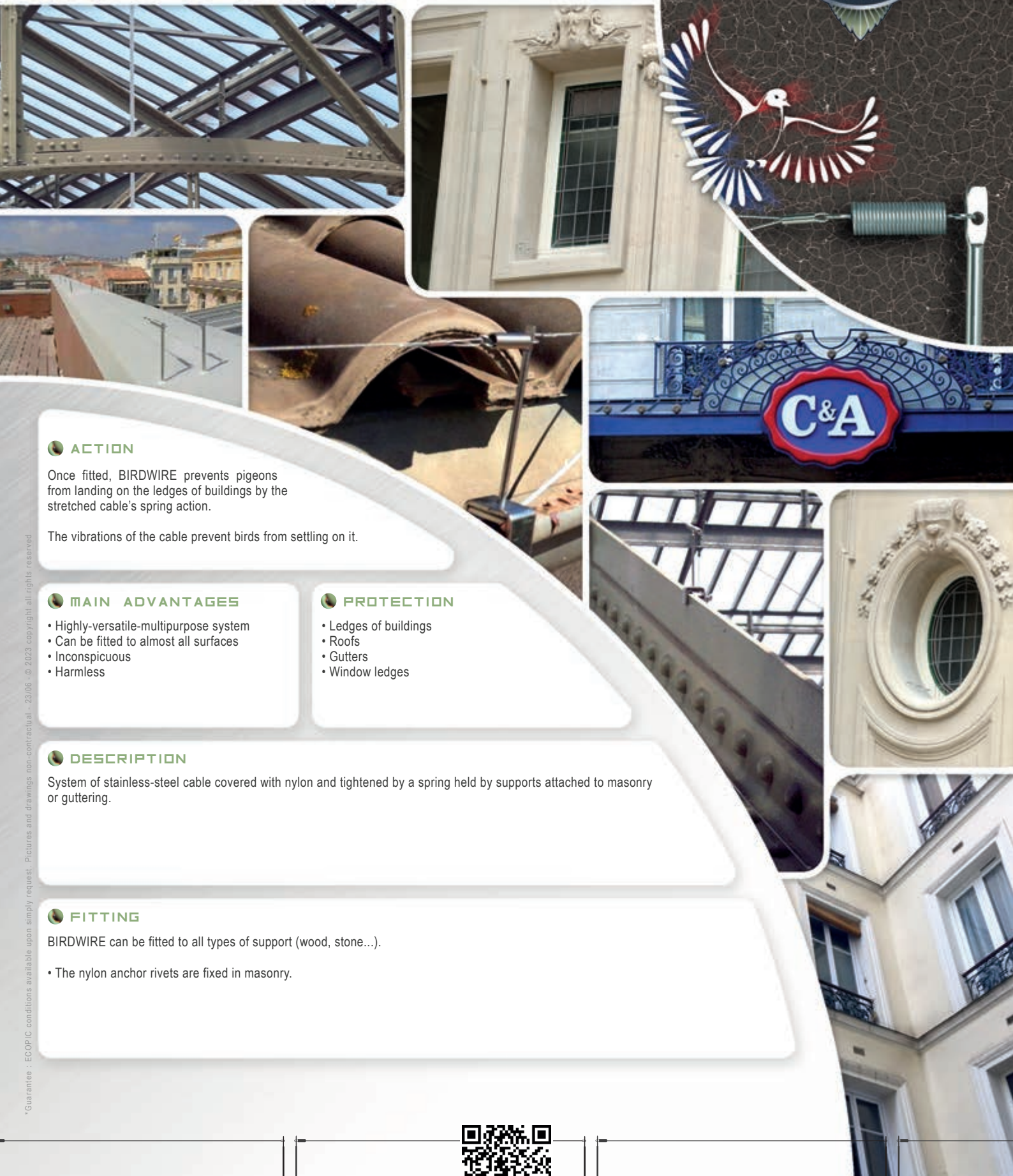

ACTION

Once fitted, BIRDWIRE prevents pigeons from landing on the ledges of buildings by the stretched cable's spring action.

The vibrations of the cable prevent birds from settling on it.

MAIN ADVANTAGES

- Highly-versatile-multipurpose system
- Can be fitted to almost all surfaces
- Inconspicuous
- Harmless

PROTECTION

- Ledges of buildings
- Roofs
- Gutters
- Window ledges

DESCRIPTION

System of stainless-steel cable covered with nylon and tightened by a spring held by supports attached to masonry or guttering.

FITTING

BIRDWIRE can be fitted to all types of support (wood, stone...).

- The nylon anchor rivets are fixed in masonry.

*Guarantee - ECOPIC conditions available upon simply request. Pictures and drawings non-contractual - 23/06 - © 2023 copyright all rights reserved





Stretched-wire system to prevent pigeons from setting on the ledges of buildings. Recommended for low bird pressures.

STAINLESS-STEEL ROD

REF.	DESCRIPTION	PACKAGING
BIR004	Stainless-steel rod 11 cm	100

BIRDWIRE anti-bird rods are made of stainless-steel. Their flat head has a hole with rounded edge to avoid wear on the cable caused by friction. The other end of the rod is chamfered for easy insertion in the anchor rivet

On wide cornices where pigeons settle, 11 cm supports are recommended to vary cable heights every 0,60 m.

- Protected width : 3 cm.

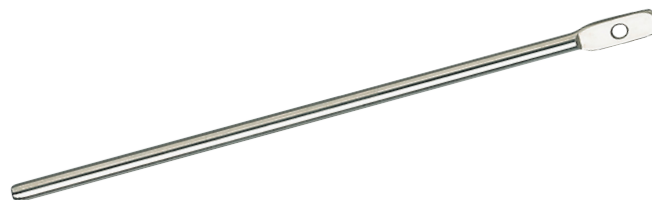

ANCHOR RIVETS

REF.	DESCRIPTION	PACKAGING
BIR010	BIRDWIRE 25 mm anchor rivets	100

BIRDWIRE anchor rivets are used to attach stainless-steel rods or round splits pins to stone, brick or other suitable materials...

They are made of highly-resistant thermoplastic nylon.

Their flattened head fits closely to the surface to be protected and the form of the fluted ridge located at the end of the rivet secures it firmly.

Make the seal.



ACCESSORIES

PIN EYE BOLT

Ref.: NET080

Description : Hook 4,8cm drill bit

Packaging : Unit

- Special windowsills.
- Used with BIRDWIRE cable to protect edge of the window.



BIRDWIRE SPRING

REF.	DESCRIPTION	PACKAGING
BIR009	BIRDWIRE spring	100

These springs are specially made from stainless-steel and have a small opening in the ring at one end to facilitate attachment to stainless-steel rods or round split pins.



BIRDWIRE CABLE

REF.	DESCRIPTION	PACKAGING
BIR001	BIRDWIRE stainless-steel cable	100 M spool

A seven-strand stainless-steel cable covered with UV-stabilised nylon, with a total diameter of 0,7 mm and a tensile strength of 22 kg.



BIRDWIRE CLAMPS

REF.	DESCRIPTION	PACKAGING
BIR012	BIRDWIRE clamps	100

Nickel-plated copper BIRDWIRE crimps are used to fix the cable to stainless-steel rods or to the round splits pins.

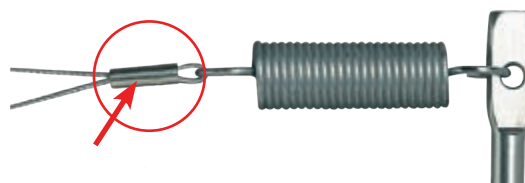

STAINLESS-STEEL GUTTER ROD

REF.	DESCRIPTION	PACKAGING
BIR019	Stainless-steel gutter rod	10

Stainless-steel gutter rods can be used to fix the cable to the rim of virtually all gutters.

They must be attached to the gutter every 0,60 m with the bolt placed inside the gutter.

The serrated jaw of the clamp prevents the rod from sliding sideways.

- Protected width : 3 cm.

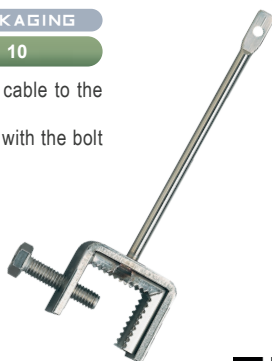

STAINLESS-STEEL ROOF ROD

REF.	DESCRIPTION	PACKAGING
BIR026	Stainless-steel roof rod	10

Ideal for protecting the edges of roof is fixed on the tile, spaced at intervals of 0,60 m.

- Protected Width : 3 cm.





Anti-bird protection system adaptable to the widest range of environmental conditions.



ACTION

Square-mesh anti-bird nets are designed to protect large spaces.

MAIN ADVANTAGES

- Long-lasting
- Ecological
- Inconspicuous
- Cost effective

PROTECTION

- Sloping roofs
- Inner courtyards
- Balconies
- Metal structures or industrial premises
- Ceilings
- Bell towers
- Trees
- Car-park interiors

DESCRIPTION

High-density polyethylene square-mesh nets, knotted and mass UV-stabilised.

Chemically inert, rot-proof, highly resistant to different weather conditions and a very wide range of chemicals.

These nets are not anti-fall nets, which have different specifications.

FITTING

- First make a sketch to determine the number of screw eyes and turnbuckles needed.
- Fix screw eyes every 50 cm around the perimeter and turnbuckles at corners.
- Bring the stainless-steel wire rope through the eyes and tighten it with the turnbuckles (1/10 meters).
- Fix the wire rope to the turnbuckles with u-bolts.

- Attach each mesh of the net to the wire rope with a ring (stainless-steel or aluminium staple fastened with the net stapler).
- Refer to the installation guide in each net for further details more over our team is available to help you.

For the dimensions (<25 m2) use of **FIXNET®** recommended (consult us)





Anti-bird protection system adaptable to the widest range of environmental conditions.



BLACK 50 MESH* SHEET NET

COLOR	REF.	DESCRIPTION	PACKAGING
BLACK	NET109	5x5 Meters net	25 M ²
	NET103	10x10 Meters net	100 M ²
	NET104	20x20 Meters net	400 M ²
	NET110	10x100 Meters net	1000 M ²
STONE	NET108	5x5 Meters net	25 M ²
	NET106	10x10 Meters net	100 M ²
	NET117	20x20 Meters net	400 M ²
	NET107	10x100 Meters net	1000 M ²
TRANSLUCENT	NET123	10x10 Translucent net	100 M ²
	NET123C	10x100 Translucent net	1000 M ²
M1	NET303	10x10 Meters net**	100 M ²
	NET304	20x20 Meters net**	200 M ²
	NET310	10x100 Meters net**	1000 M ²

M1 CLASSIFICATION REPORT ON REQUEST

BLACK 19 MESH* SHEET NET

COLOR	REF.	DESCRIPTION	PACKAGING
BLACK	NET111	5x5 Meters net	25 M ²
	NET101	10x10 Meters net	100 M ²
	NET102	20x20 Meters net	400 M ²
	NET112	10x100 Meters net	1000 M ²
STONE	NET114	5x5 Meters net	25 M ²
	NET105	10x10 Meters net	100 M ²
	NET113	10x100 Meters net	1000 M ²
TRANSLUCENT	NET124	10x10 Translucent net	100 M ²
	NET124C	10x100 Translucent net	1000 M ²
M1	NET301	10x10 Meters net**	100 M ²
	NET312	10x100 Meters net**	1000 M ²

M1 CLASSIFICATION REPORT ON REQUEST

NET* MADE TO MEASURE

ON REQUEST

* OUR NETS ARE NOT ANTI-FALL, USE WITH BIRDS ONLY
 ** CLASSIFIED M1 NETS



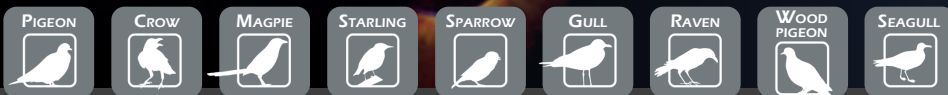

Anti-bird protection system adaptable to the widest range of environmental conditions.



ACCESSORIES FOR NET

REF.	DESCRIPTION	PACKAGING
NET ZIP		
NET140	Stone Net zip	0,50 M
NET141	Stone Net zip	1 M
NET142	Stone Net zip	2 M
NET143	Black Net zip	0,50 M
NET144	Black Net zip	1 M
NET145	Black Net zip	2 M

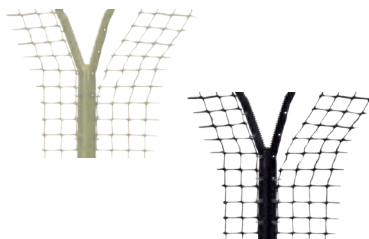

- To allow access to certain areas after application of net.
- Ready to put (Pre-breakthrough)
- A secure with staples.

NET STAPLER		
NET009	Net stapler	Unit
NET012A	Stainless-steel staples	1000
NET013A	Alu staples	1000



This is the standard tool used to fixing the nets to the wire rope.

Designed for quick use with one hand, it is essential to attach each mesh to the wire rope.

The ring staples are packed in boxes of 1000 pieces.

FIXNET®		
NET021	Fixnet®	500
NET022	Fixnet® Ready	500

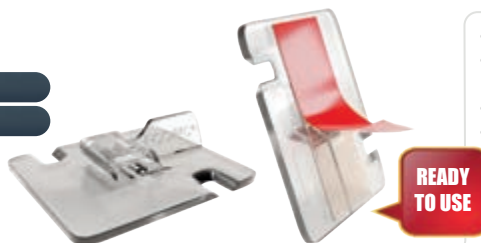

- Material : 100% virgin polycarbonate
- UV treated in the mass
- Dimensions: 30 x 35 mm
- Thickness: 10 mm max



NET FIXING		
NET032	Zinc M6 netbolt	Unit
NET033	Stainless steel M6 netbolt	Unit



The netbolts are used as standard fixing of nets angles, they can also be used to support the cross cables of large nets.





Anti-bird protection system adaptable to the widest range of environmental conditions.



REF.	DESCRIPTION	PACKAGING		
ROPE				
NET115	3 mm rope	1kg = 250 M		Black polyethylene rope for nets.
TURNBUCKLE				
NET016	M6 stainless-steel	Unit		Eye-and-hook turnbuckles are used to tighten the wire rope.
WIRE ROPE				
NET007A	Cable 2mm 7/7 stainless steel	50 M		A 2 mm 7/7 wire rope is the standard support for anti-bird nets. It combines resistance and flexibility. Stainless steel / Galvanised steel.
NET020A	Cable 2mm 7/7 galvanised steel	50 M		
PEAK WITH SCREW				
NET040	40 mm zinc screw eye	100		These supports can be directly screwed into wood or into masonry with a nylon plug.
NET132	Plastic plugs (6 mm)	100		
CRIMP				
NET017	Crimp	10		The crimp are used to link the cable at tensioner.
U-BOLT				
NET018	Stainless-steel U-Bolt	10		U-bolts are available in stainless-steel. They are used to join lengths of wire rope.
TRUSS CLIP				
NET101B	3-10 mm zinc coated truss clips	Unit		Allows the attachment of the cable to a metal IPN (3 - 15 mm) without drilling.
NET101C	10-15 mm zinc coated truss clips	Unit		
IMMEDIATE FIXING				
NET080	4.8 cm thread hook	Unit		4.8 cm and 5.5 cm thread hook of hit in solid building materials (concrete, brick, natural stone). Check the thred hook compatibility with material.



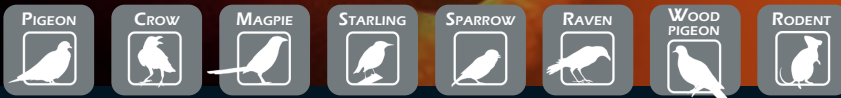

Adaptable grid for clothing the tiles



DESCRIPTION

Using for all mediterranean-style tiles, 'high profiled tiles'.

Possibility of using a dot of glue to optimize fixing.

The outer part of the grid adapts to various forms of tiles.
Prevent the intrusion of pests while maintaining the ventilation of the roof.
Easy installation (by nailing or screwing) on the fascia board.

The grid can also be installed with glue by folding the lowerpart 90°:

- 1) Seal the chimney flashings, skylights, solar panels.
- 2) Roof tiles closures, fitted on the hips and valleys roof.



 ECOPIIC® tile products comply with all french standards requirements for ventilation of roofs (DTU 40.21, 40.22...)



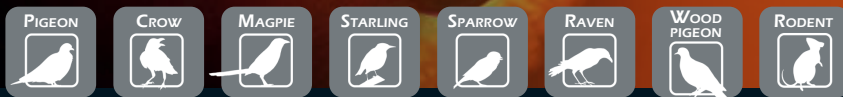

Adaptable grid for clothing the tiles



ECOPIC® TILE TR

REF.	DESCRIPTION	PACKAGING
STOP010	ECOPIC® Tile TR	box of 50 units

- Grid :
- Double sided lacquered aluminium.
 - Thickness : 0,70 mm
 - Height : 85 mm
 - Width : 150 mm

- + Removable mouting clips, red tile colour :
- Lackered steel
 - Height : 20 mm
 - Width : 85 mm

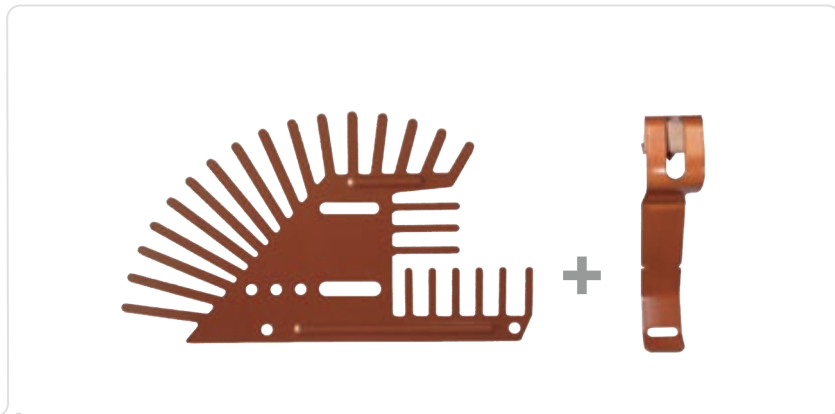

ECOPIC® TILE TV

REF.	DESCRIPTION	PACKAGING
STOP011	ECOPIC® Tile TV	box of 50 units

- Grid :
- Double sided lacquered aluminium.
 - Thickness : 0,70 mm
 - Height : 85 mm
 - Width : 150 mm

- + Removable mouting clips, old tile colour :
- Lackered steel
 - Height : 20 mm
 - Width : 85 mm



ECOPIC® TILE GS

REF.	DESCRIPTION	PACKAGING
STOP012	ECOPIC® Tile GS	box of 100 units

- Grid :
- Double sided lacquered aluminium.
 - Thickness : 0,70 mm
 - Height : 85 mm
 - Width : 150 mm

Single grid, installation without removable mounting clips.

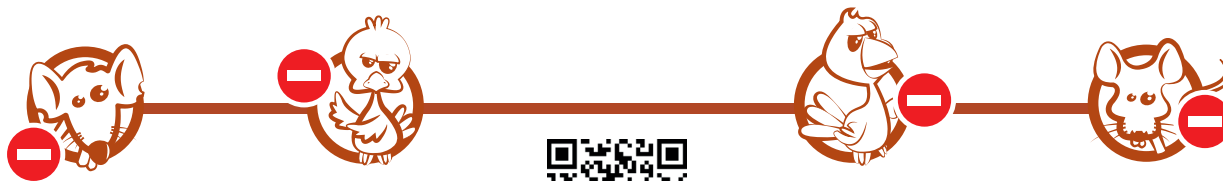



PREDATOR® is absolutely harmless for environment and for birds that it scares.



ACTION

Simply, highly effective bird repellent.

MAIN ADVANTAGES

- Birds are immediately scared by the movements of the balloon which simulates a real predator.
- Absolutely harmless for environment

PROTECTION

- Balconies
- Trees
- Vegetable crops
- Play areas
- Swimming pool...

DESCRIPTION

- Waterproof - PVC conception
- 15 cm Ø
- Luminescent circles
- Bright colours
- To inflate

FITTING

- Hang the balloon anywhere, in a visible height for birds.
- Normal use in agriculture or arboriculture : 1 balloon each 500 m².
- Industrial use : 15 balloons per hectare.
- To protect a terrace or balcony : 1 balloon.
- To be most effective, **PREDATOR®** needs to be installed in alternating colours each 3 weeks.

SPECIAL FOR BALCONIES





PREDATOR® is absolutely harmless for environment and for birds that it scares.



PREDATOR®

REF.	DESCRIPTION	PACKAGING
SEL006	PREDATOR®	Kit of 3, Ø 15cm

- PREDATOR® balloons are useful in many applications home, gardens, trees, environments, play areas, swimming pool, and many more...
- Waterproof - PVC conception
- The PREDATOR® kit includes 3 balloons (yellow, white, black)

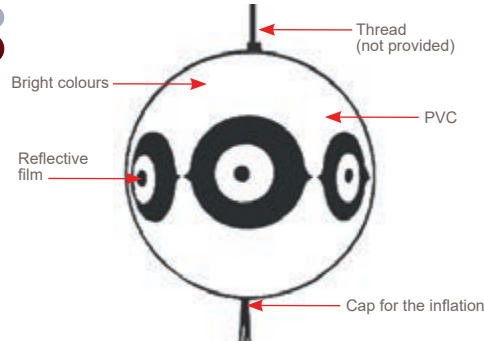

DESCRIPTIVE

PREDATOR® is designed in waterproof PVC, with drawings (designs) that represent the wide open mouth and piercing eyes of a predator. Balloons move in the wind (from bottom to top, from left to right) and its metal ribbons simulate a real predator and scare the birds.

When inflated, PREDATOR® must be hang on a support or a tree in a visible height for birds. For normal use, we recomand 1 balloon each 500 m². For an industrial use, 15 balloons per Ha.

PREDATOR® is immediatelly effective. Includes three balloons : one white, one yellow, one black. Our research has shown that to be most effective, PREDATOR® needs to be installed in alternnating colors each 3 weeks.

PREDATOR® is absolutely harmless for environment and for birds that it scares. It is the absolute answer for agronomical environments, play areas, swimming pool, balconies, etc.





Adhesive anchor for bait station

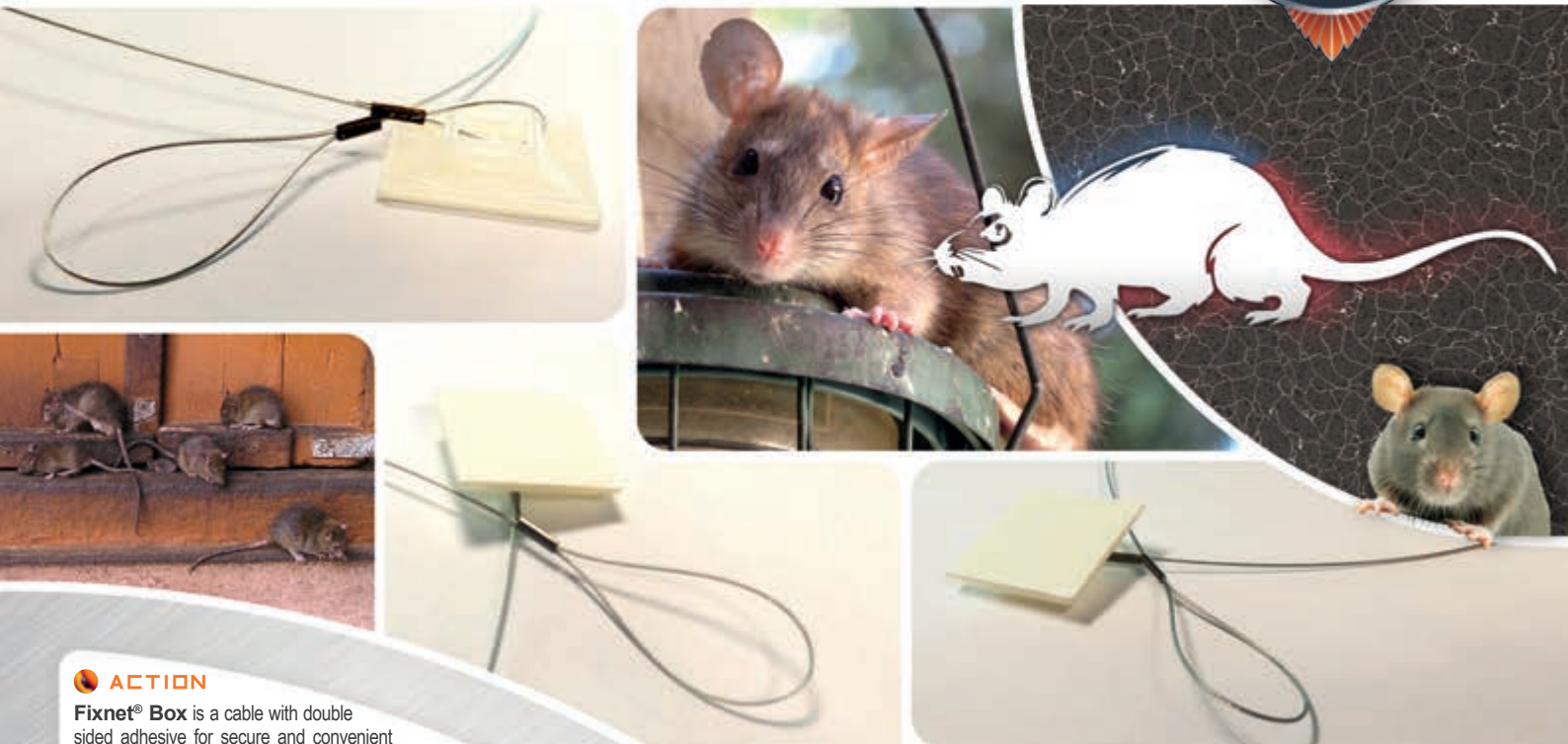

ACTION

Fixnet® Box is a cable with double sided adhesive for secure and convenient installation, that facilitate maintenance of rodent bait boxes. It is a professional accessory used for bait boxes.

Allows to fight more effectively against the profiling of rodents in a very secure way (control and filling of boxes) in accordance with regulatory standards and requirements.

MAIN ADVANTAGES

- Economical
- Ready to fit
- Facilitates maintenance during treatment
- Suitable for all bait boxes

PROTECTION

- Restaurant and community kitchens
- Food storage areas
- All areas frequented by rodents (interior use)

DESCRIPTION

- Highly resistant flexible cable in sheathed stainless steel. Used to fix all types of bait stations.
- It has a loop at each end.
- Allows a reliable, fast and precise fixing.

Two models available :

- **Fixnet® Box** 60 cm (Ref: NUI023)
- **Fixnet® Box** 40 cm (Ref: NUI024)

FITTING

Apply on a suitable, clean and dry surface. Outside influences such as temperature, moisture and vandalism can influence its function / adhesive strenght.

Regularly check the correct positioning of the adhesive support during the maintenance of the bait boxes.

Insatallation : Optimun weather conditions

- Temperatures between +5°C and +30°C, sheltered from rain.

Preparation of the surface :

- Cleaning with **SELCLEANING®**
- Removal of dust, dirt and grease, drying

Simple, fast, precise fitting :

- By gluing thanks to its integrated adhesive.
- By thumb pressure, it is immediately operational.

WARNING :

Take care not to obstruct the emergency exits when installing the **Fixnet® Box**.





Adhesive anchor for bait station



FIXNET® BOX 60

REF.	DESCRIPTION	PACKAGING
NUI023	Fixnet® Box	Kit of 200 pieces

- Adhesive anchor for bait station
- Length **60 cm**
- Kit of 200 pieces cable with double sided adhesive allows strong adhesion on all type of support.
- Ideal for restaurant, community and other food storage areas.
- Product only intended for professional use.



FIXNET® BOX 40

REF.	DESCRIPTION	PACKAGING
NUI024	Fixnet® Box	Kit of 200 pieces

- Adhesive anchor for bait station
- Length **40 cm**
- Kit of 200 pieces cable with double sided adhesive allows strong adhesion on all type of support.
- Ideal for restaurants and communities kitchens as well as other food storage areas.
- Product only intended for professional use.

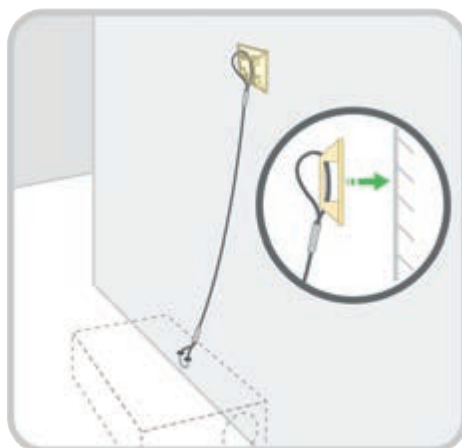



EGOPIE
ZAC DU MOULIN
12 RUE DU MEUNIER
95700 ROISSY EN FRANCE - FRANCE

PHONE: +33 (0) 21 27 20 40

FAX: +33 (0) 21 27 24 50

MAIL: EGOPIE@EGOPIE.COM

